

INSTRUCTIONS FOR USE

Verseo
DUET™

DUET – INSTRUCTIONS FOR USE

The new patented 2-In-1 Verseo DUET is the only hair removal system that features both Epilator and Shaver in one.

With your new Verseo DUET you can quickly and effectively remove hair from the root. The Verseo DUET removes hair from your arms, legs, and other large surface areas of your body. The innovative and patented epilating head grasps even the shortest hairs leaving skin silky smooth. The two-speed option allows the user to choose desired speed for most efficient hair removal.

Use the shaving head to shave away hair from sensitive areas.

Curved ergonomic shape fits contour of your body.

Built-in trimmer.

BEFORE USE, PLEASE READ ALL THE INSTRUCTIONS CAREFULLY!

BEFORE USE

Wash respective skin areas with soap and warm water and dry thoroughly. Do not apply any body lotion or other substances such as talc. Expose any in-growth hair by rubbing a coarse sponge or loofah over your respective skin area, against the hair's direction of growth.

PREPARING THE APPLIANCE

Check that the voltage indicated on the transformer corresponds to your home voltage and use only our special 12 V transformer.

EPILATION

Remove the top cover A and the bottom cover B from your DUET while

ATLANTIC HORIZON INTERNATIONAL, INC. makes every effort to ensure that its products are manufactured without any defect. However, in the rare event of defect due to faulty workmanship or materials, we guarantee to repair or replace the product, or any part thereof, free of charge.

This guarantee is granted to the original purchaser only for one year and does not apply if the product is altered or repaired or otherwise tampered with by unauthorized persons and/or is used other than in accordance with the manufacturer's instruction and/or is subjected to other than reasonable use of a product of its nature.

To return the unit, please call **562-948-1114** for Return Authorization Code and shipping instructions. Package sent without authorization code will not be accepted.

WARRANTY

holding your appliance by the two side covers (fig. 1). Cover the shaving head with the bottom cover: the epilating head is now ready for use. Connect the transformer, first to the appliance, and then to an electric outlet. Stretch the skin taut. Place the device at a slight angle to your leg, with the switch facing you (fig. 2). Turn the appliance on, at the desired speed, (fig. 3) and move in circular movements, lightly skimming the skin's surface, without pressure (fig. 4). Be careful when using the appliance on sensitive areas. Shaving these areas instead of epilation is recommended. **TO REMOVE HAIR FROM BEHIND-KNEE AREA** Always keep skin stretched in order to prevent its being pinched by the rotating head (fig. 5).

SHAVING

Cover the epilating head with the bottom cover while holding your DUET by the side covers (fig. 1). Shave by lightly moving the appliance over the surface of your skin. If the hairs are longer than 10 mm they should first be shortened with the trimmers, allowing the foil screen to attain a very smooth shave. Use the straight trimmer on more-or-less flat areas of skin. For less-accessible skin, in areas such as the armpit, it is best to use the curved trimmer.

AFTER USE

A slight irritation and/or redness may appear on the skin, especially after the first use. This should disappear after a short time. If the irritation persists for 48 hours or more, please consult your doctor. Any moisturizing cream will refresh your skin and should be applied shortly after epilation.

CLEANING AND MAINTENANCE

Clean the heads thoroughly after every use.

Epilating Head

Remove all the hairs accumulated between the metal and plastic parts with the cleaning brush (fig. 6).

Shaving Head

Never clean the shaving head's foil screen with the cleaning brush!

After every use: Remove the shaving unit by pulling it off (fig. 7). Tap the

Distributed by
ATLANTIC HORIZON INTERNATIONAL, INC.
New York, New York 10165

Visit our website at
www.verseo.com
for more Verseo products

ITEM NO. AT55-07

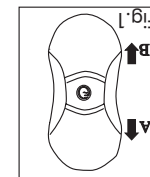
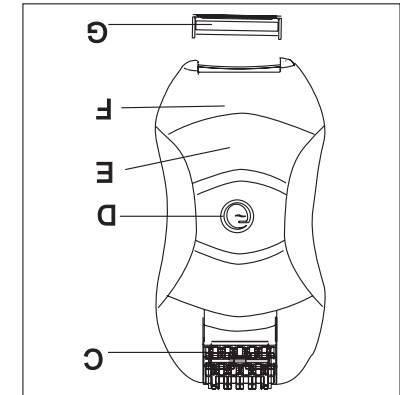
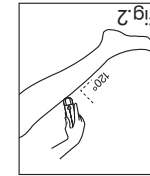
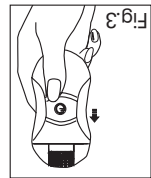
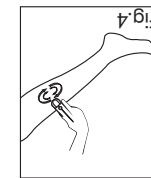
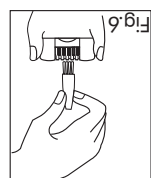
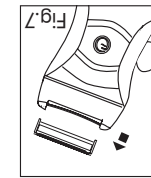

bottom gently on a flat surface (fig. 8). Brush out the bottom and the trimmers but not the screen. Replace the shaving unit by clicking it into place (fig. 7).

Do not clean the heads in water or any other liquid. Remove residues or grease with your cleaning brush dipped in pharmaceutical alcohol.

IMPORTANT!

Use the original transformer supplied with the appliance only. Do not use the appliance on open cuts, bruises, sunburn or blisters. If your skin is sensitive, or if you suffer from varicose veins, hemophilia or a skin disease, consult your physician before using the appliance. While working, the appliance should never come in contact with your head's hair or eyelashes.

•This appliance should never be used near water (i.e. filled sink, bathtub or shower).

Keep the appliance out of the reach of children.

Before use, check if your voltage corresponds to the voltage printed on the adaptor. Use only the included 12V adaptor. Do not use if the appliance, its cord or the plug is damaged or if you accidentally drop the appliance. Make sure that the cord is not damaged by sharp objects.

Do not modify the unit or its cord. For repairs you should contact a professional service center. Keep out of reach of children.

Do not leave the adaptor plugged into electric outlet after use.

APPLIANCE PARTS

(Please see illustrations on the following page)

- | | |
|-------------------|-------------------|
| A. Top Cover | E. Appliance Body |
| B. Bottom Cover | F. Shaving Head |
| C. Epilating Head | G. Shaving unit |
| D. ON/OFF Switch | |